

AVITEQ
Vibrationstechnik GmbH

formerly **AEG** Vibrationstechnik

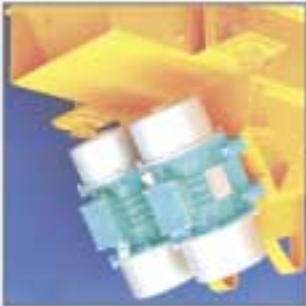

**Unbalance Motors –
Drives to Keep Your Bulk
Material on the Move**

We move you forward.

Unbalance Motors in Process



Trough conveyor to charge an elevator with up to 12 m³/h glass batch

Fields of application

High transporting power for small equipment sizes, a long service life, rugged design, efficiency and the latest in terms of manufacturing technology—these are just some of the features of AViTEQ unbalance motors.

You can count on AViTEQ unbalance motors for reliable operation whether the work involves gravel de-watering, classifying, dust removal or screening, transporting large quantities or special tasks in chemical engineering, such as concrete compacting, dosing or loosening material.

Our unbalance motors are the answer for a perfect and economical drive whether extracting or processing raw materials in the chemical or pharmaceutical industries, in the production of foodstuffs or in machine and plant constructions. Take advantage of our 50 years of experience from former AEG Vibrationstechnik in vibration-based materials handling technology covering almost all conceivable fields.

Unbalance motors are suitable as drives for trough and tubular vibrating conveyors, vibrating and bar screens, vibrating hoppers and tables, helical conveyors and de-watering devices. They ensure a trouble-free flow of material in operation as activators for silos, bunkers, shake-out grids, fall pipes, slides, filters and filling machines.

The motors can move equipment of over 11,000 kgs off dead weight with their working moments from 0.1 kgcm to 2,763 kgcm and centrifugal forces up to 119 kN. High transport performance can be achieved and long delivery distances can be overcome through the combination of a number of materials handling devices, using parallel drives and individual design of vibration equipment. The rugged design enables trouble-free use in continuous operation round the clock. The comprehensive range of motor types offers you the best drive materials handling requirements from a few kg/h through to more than 5,000 m³/h.



Trough and tubular conveyors and screens which are specially designed for the stringent hygiene standards of the foodstuffs industry are used for vegetable processing



Extreme environmental conditions in paper recycling place high demands on the sealing of housings



PVC granules must overcome large differences in height in a confined space of ground. Spiral conveyors offer the possibility of processing the conveyed material in addition to the transport function

Quality

All components and assemblies are inspected during manufacture after each stage, using the latest measurement equipment. The certified quality checks from goods reception through final inspection guarantee you reliable products and ensure fault-free operation. Each drive unit is subjected to a routine check test under load before shipping to ensure proper functioning and operational reliability in your plant. Generously dimensioned tapered and cylindrical roller bearings, a precision ground armature shaft in tempering steel and the strong cast housing guarantee a long service life and maintenance-free operation.

Service

Our customers have come to take for granted the excellent, fast service provided by our team of technicians. This means we reduce downtimes and help you to save costs.

Of course, we will advise and assist you during the design and project planning of your application. Our engineers would be pleased to help you with their in-depth expertise in processes and plant engineering.



Enclosed conveying protects from unwanted contamination of the transported material and of the environment

The Technology

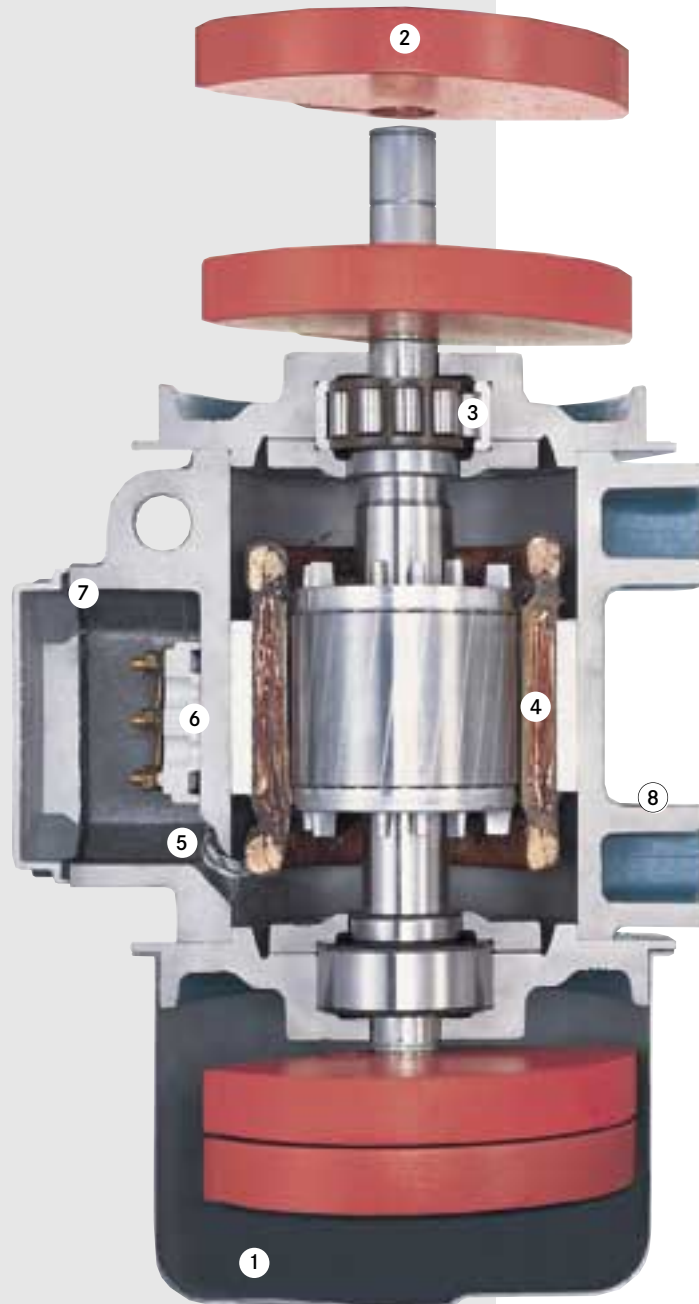

High performance and reliability with economical procurement and operating costs – these are good reasons for specifying AViTEQ unbalance motors. Our unbalance motors are well known for their long life, rugged construction and highest standards of manufactured quality. We are offering a particularly favourable price/performance ratio with our latest range of unbalance motors. Permanent tests in our own test laboratory support the on-going development and optimisation of our products.

- 1 Cover**
Easy to fit; sealed against dust and water (IP 66 protection) by O-ring flange seal, from Model Size F to L in stainless steel.
Advantage: Shorter downtimes for maintenance
- 2 Unbalance weights**
Adjustable, permanently legible setting scale.
Advantages: Quick and precise setting
- 3 Rotor bearings**
Oversized tapered/cylindrical roller bearings; pre-packed lubrication; maintenance-free.
Advantages: Long service life; low maintenance costs; continuous operation at 100% centrifugal force setting
- 4 Winding**
High quality winding, impregnated in resin and vibration-resistant; impervious to moisture and dust; armature shaft in alloyed tempering steel.
Advantage: Operational reliability in harsh environments
- 5 Thermistor**
Thermistor protection from Model Size E as standard; trouble-free operation using speed control units.
Advantages: Motor protection for unpredictable operating states; universal application; low failure costs
- 6 Terminal board**
6-pole version (voltages up to 660 V without additional insulation); encapsulated.
Advantages: Solidly mounted; no risk of vibration fatigue failure
- 7 Cable gland**
Simple electrical connection; IP 66; second separate cable gland for thermistor connection.
Advantages: Easy to fit; high operational reliability
- 8 Housing**
Tall feet enable the use of long expansion lengths of the mounting screws; mounting in any position possible; housing for high stresses; large thermal reserve.
Advantages: Operational reliability for high stresses; long service life

The Operating Principle of the Vibration Technique

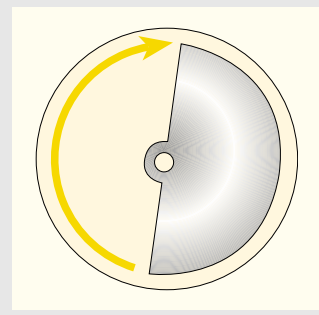

The unbalance weights on the drive shaft produce an oscillating force which sets the spring-mounted working device (e.g. a screen) to vibrating in a defined direction

The unbalance motor, a special form of the electrical motor (a three-phase asynchronous motor), is mounted directly onto a working device (e.g. screen, trough, tube) and connected electrically. There is no need for any belts, shafts, frames, fans, gear or cams. Incorrect operation is eliminated and additional protection is unnecessary.

Elliptical, circular or linear vibratory movements of the working device can be produced using unbalance motors, depending on the arrangement.

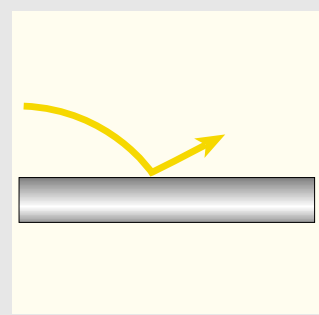

The bulk material is transported by a micro-projection motion due to the vibration of the equipment

A straight, linear vibratory movement is produced, enabling linear transport of material, when using double drive units, e.g. with vibrating trough or tubular conveyors with two unbalance motors running synchronously in opposite directions.

Single drives which are arranged at the centre of gravity produce a circular vibratory movement, e.g. for screening. An elliptical movement is produced, e.g. for compacting or agitating hoppers, when single drives are mounted away from the centre of gravity.

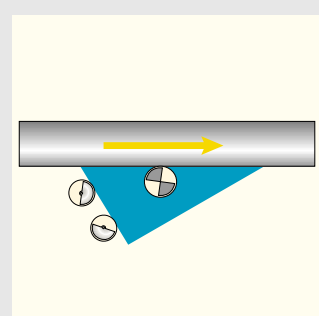

Two counter-rotating unbalance motors are required for linear vibratory movement

The type of vibratory movement therefore depends on the arrangement of the drive relative to the centre of gravity of the working device. It is best to mount the motors in the vertical orientation.

Direction of rotation

The motors must rotate in opposite directions in order to produce a linear vibration as required for longitudinal conveyors such as trough conveyors or vibrating screens. In contrast, equipment which produces torsion vibrations needs drives rotating in the same direction. Motor operation in the wrong direction, even though brief can cause serious damage to the working devices.

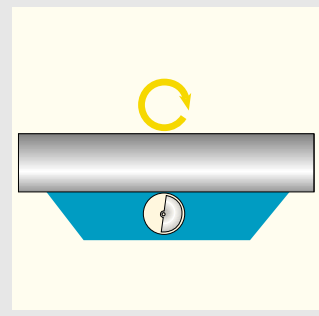

A single drive mounted at the centre of gravity produces circular vibrations

The motors must be mounted on a part of the device which is rigid to bending, otherwise there is a risk of fracture and the motors cannot automatically synchronise. Furthermore energy consumption of the motors would rise to unacceptable levels. Transverse vibration monitoring is employed with large, long conveying equipment to indicate when incorrect rotation occurs.

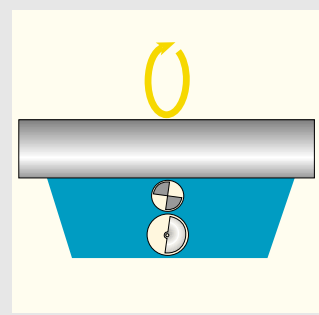

A single drive produces elliptical vibrations when mounted away from the centre of gravity

Design and Motor Selection

Design

The vibration amplitude is the sole decisive factor in calculating the operation of unbalance motors. The forces, transferred from the motor to the working device, can be calculated most simply from the acceleration figures at the relevant drive frequencies and the vibration amplitude. You can just take the effective vibration amplitude for all types of motors in relation to the working weights from the motor characteristics on the following pages. It is easy to find the best drive for your application.

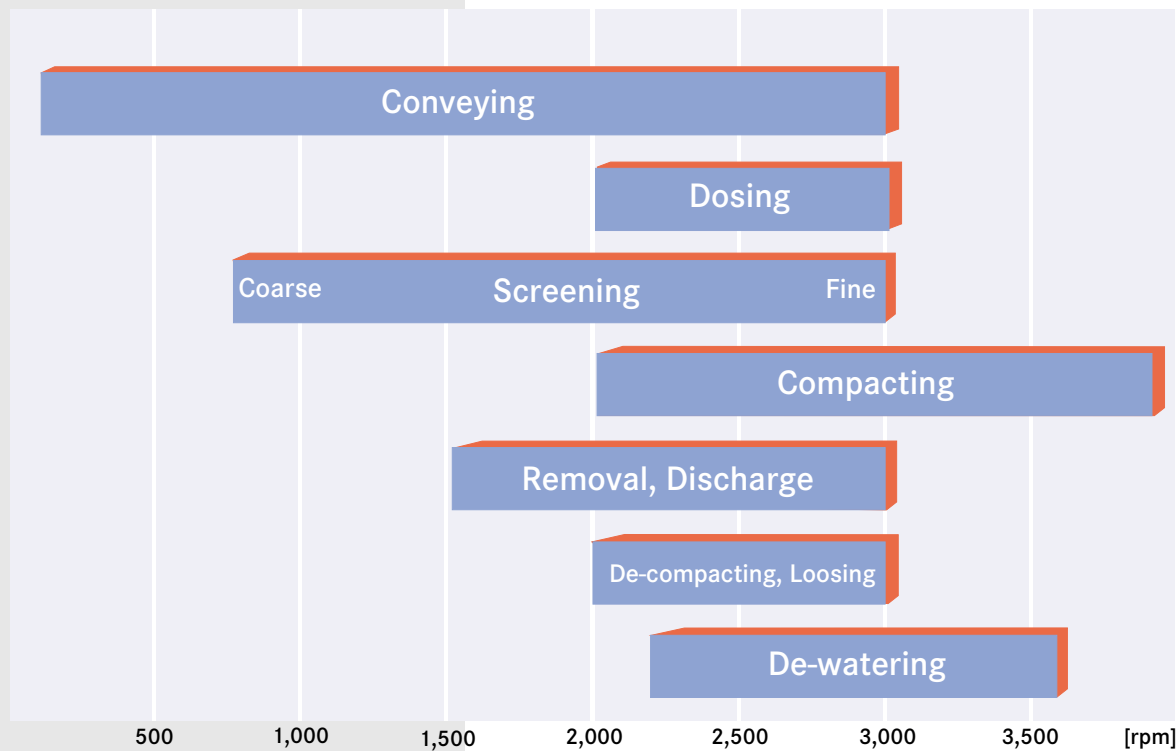

The vibration amplitudes and acceleration values suitable for various applications depend on the nominal speed in the relevant mains supply.

Summary of Performance Data

Range of centrifugal force: From 40 to 119,000 N
 Working moment: From 0.08 to 2,763 kgcm
 Synchronous speed:
 in 50 Hz network: 750, 1,000, 1,500, 3,000 rpm
 in 60 Hz network: 900, 1,200, 1,800, 3,600 rpm
 Working weight: From 1 to 11,250 kgs
 Mains connection: Three-phase 50 or 60 Hz for all common voltages up to 660 V
 Rated power consumption: From 0.03 to 10 kW
 Ambient temperature: From -25 to +40° C
 Protection: IP 66 to EN 60529, tropic-proof insulation
 Insulation class: F to VDE 0530, Part 1 and 0535b

Electrical Connection

AViTEQ unbalance motors can be supplied for mains supply voltages of 230/400 V in standard versions for 50 Hz or with 265/460 V for 60 Hz mains. We would be pleased to quote for special models and other windings for other voltages or mains frequencies if required.

Connection Methods

Our unbalance motors can be directly connected to the three-phase mains or via our various Vibtronic® connection units depending on the required operation.

You can use the Vibtronic® Brake Unit if the shortest possible run-down time after switch-off is recommended or specified. This is required particularly for large equipment and with speeds less than 1,500 rpm.

You should use the Vibtronic® Frequency Converter for drives which are to be controlled or monitored over a larger range of their revolutions (only for drives with thermistor protection).

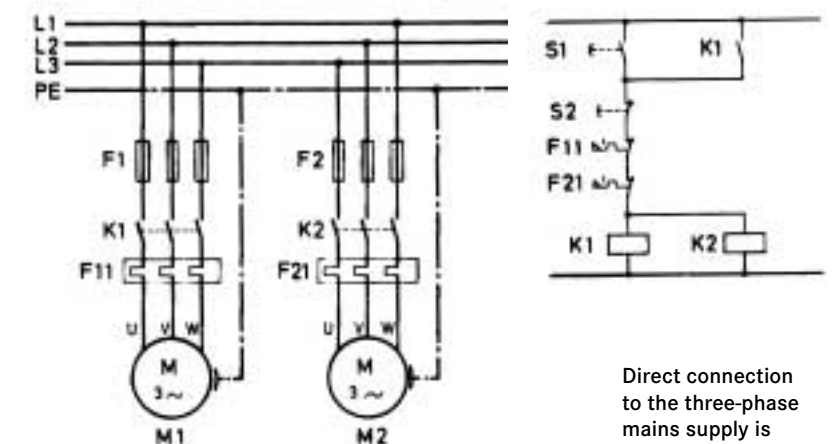

Direct connection to the three-phase mains supply is possible if no additional functions are required

 All drives according to the relevant EU-regulations.

 Drives comply to the CSA rules.

 Protected series: EEx e II T3 and/or T4 to EN 50014/50019, LCIe 00 ATEX 6005X

The Quick Way to the Right Drive

Performance graphs for 2-pole motors, synchronous speed 3,000 rpm (50 Hz)

- 1 = UVA 0,6 Y 4 = UVC 3 Y
- 2 = UVB 1 Y 5 = UVD 5 Y
- 3 = UVB 1,9 Y 6 = UVE 7,7 Y

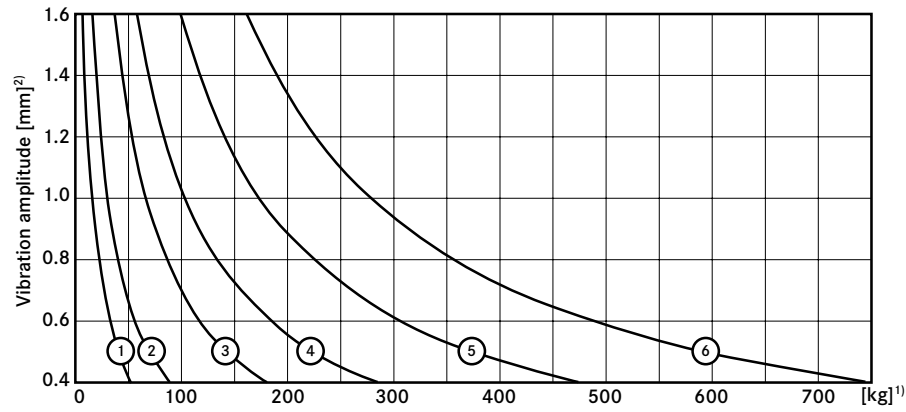

Performance graphs for 2-pole motors, synchronous speed 3,600 rpm (60 Hz)

- 1 = UVA 0,6 Y 4 = UVC 3 Y
- 2 = UVB 1 Y 5 = UVD 5 Y
- 3 = UVB 1,9 Y 6 = UVE 7,7 Y

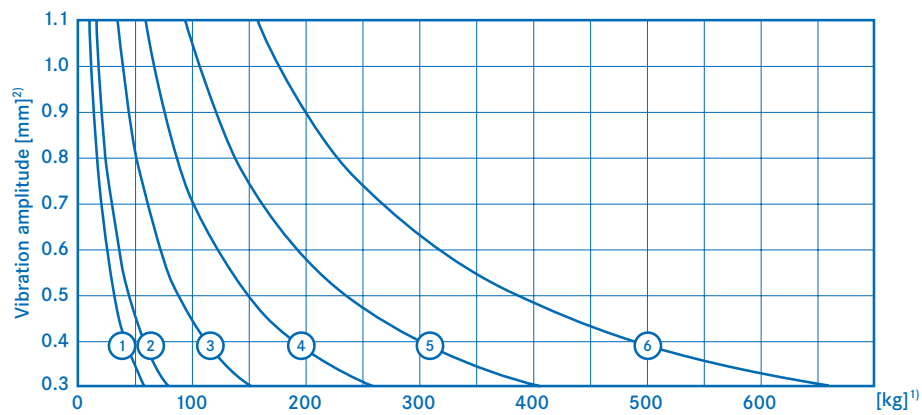

Performance graphs for 2-pole motors, synchronous speed 3,000 rpm (50 Hz)

- 1 = UVE 11 Y 4 = UVH 40 Y
- 2 = UVF 20 Y 5 = UVL 62 Y
- 3 = UVG 32 Y 6 = UVL 88 Y

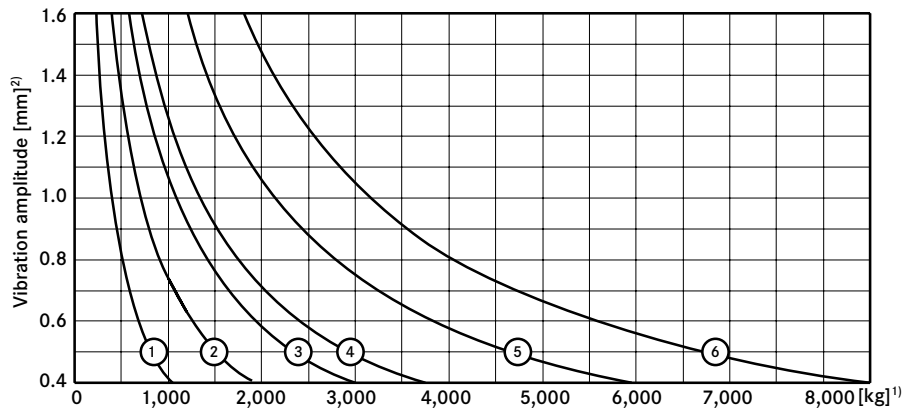

Performance graphs for 2-pole motors, synchronous speed 3,600 rpm (60 Hz)

- 1 = UVE 11 Y 4 = UVH 40 Y
- 2 = UVF 20 Y 5 = UVL 62 Y
- 3 = UVG 32 Y 6 = UVL 88 Y

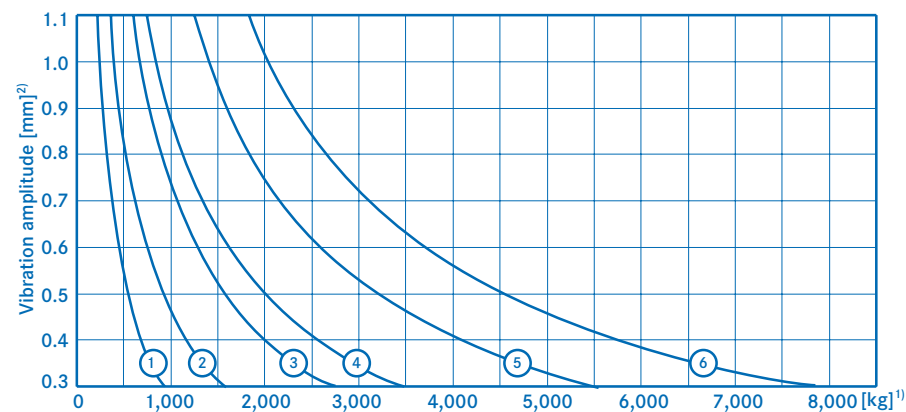

¹) Working weight [kg] for devices driven by two motors
²) Vibration amplitude from peak to peak

Performance graphs for 4-pole motors, synchronous speed 1,500 rpm (50 Hz)

- 1 = UVB 0,3 X 4 = UVC 2,1 X
- 2 = UVB 0,7 X 5 = UVD 4 X
- 3 = UVC 1,5 X 6 = UVD 5,4 X

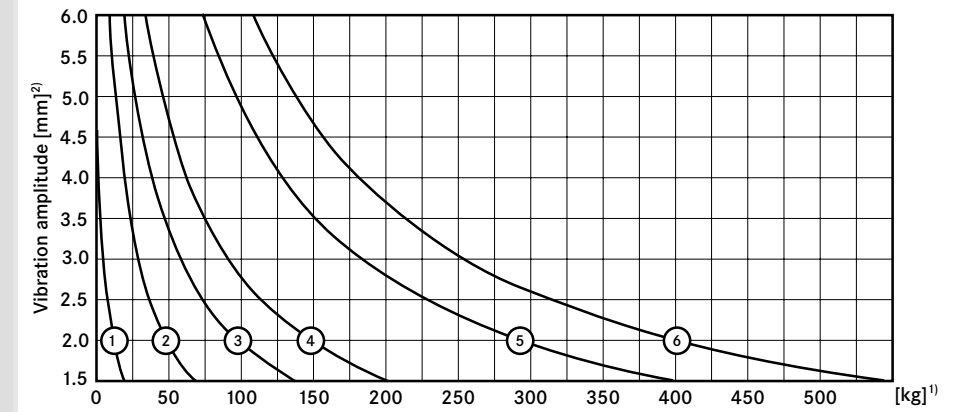

Performance graphs for 4-pole motors, synchronous speed 1,800 rpm (60 Hz)

- 1 = UVB 0,3 X 4 = UVC 2,1 X
- 2 = UVB 0,7 X 5 = UVD 4 X
- 3 = UVC 1,5 X 6 = UVD 5,4 X

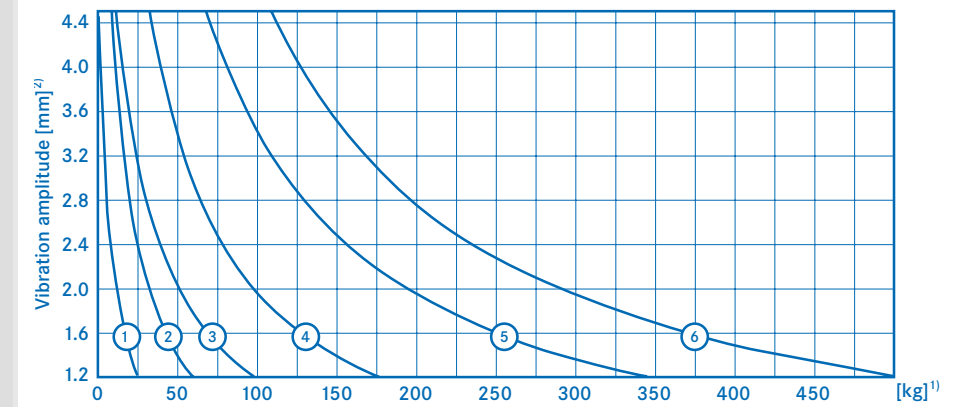

Performance graphs for 4-pole motors, synchronous speed 1,500 rpm (50 Hz)

- 1 = UVE 7 X 6 = UVH 49 X
- 2 = UVE 10 X 7 = UVL 64 X
- 3 = UVF 18 X 8 = UVN 83 X
- 4 = UVF 24 X 9 = UVP 112 X
- 5 = UVG 38 X

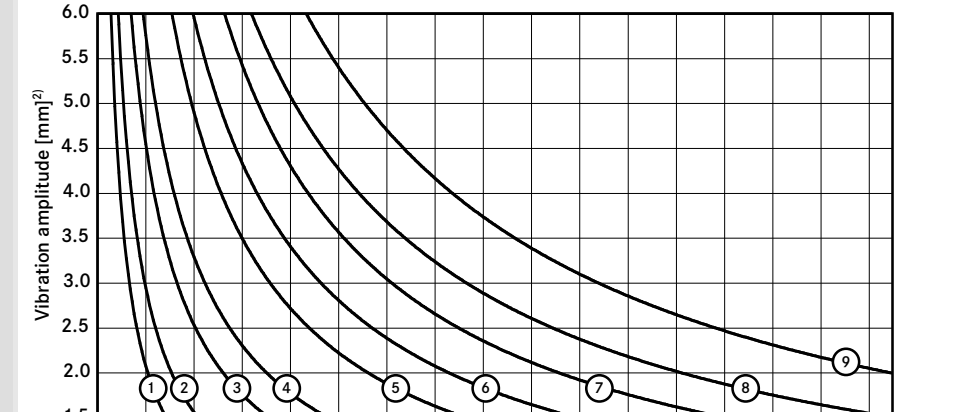

Performance graphs for 4-pole motors, synchronous speed 1,800 rpm (60 Hz)

- 1 = UVE 7 X 6 = UVH 49 X
- 2 = UVE 10 X 7 = UVL 64 X
- 3 = UVF 18 X 8 = UVN 83 X
- 4 = UVF 24 X 9 = UVP 112 X
- 5 = UVG 38 X

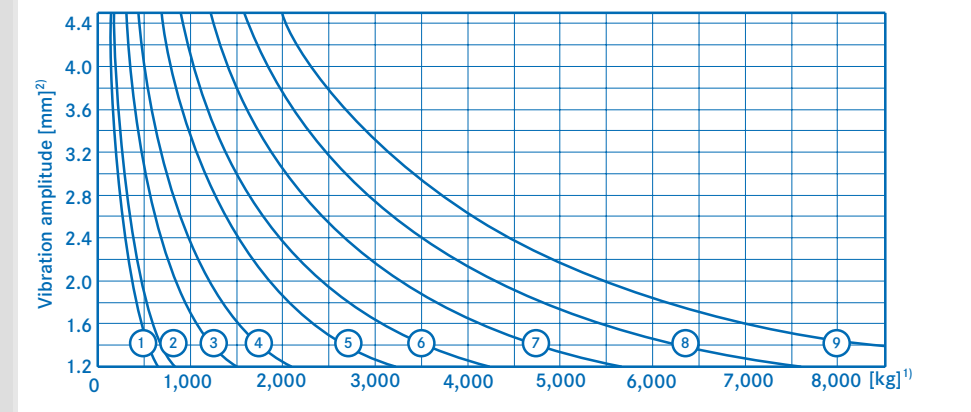

¹) Working weight [kg] for devices driven by two motors
²) Vibration amplitude from peak to peak

Performance graphs for 6-pole motors, synchronous speed 1,000 rpm (50 Hz)

1 = UVE 3 W	7 = UVH 38 W
2 = UVE 5 W	8 = UVH 46 W
3 = UVF 11 W	9 = UVL 64 W
4 = UVF 16 W	10 = UVK 79 W
5 = UVG 21 W	11 = UVN 95 W
6 = UVG 30 W	12 = UVP 119 W

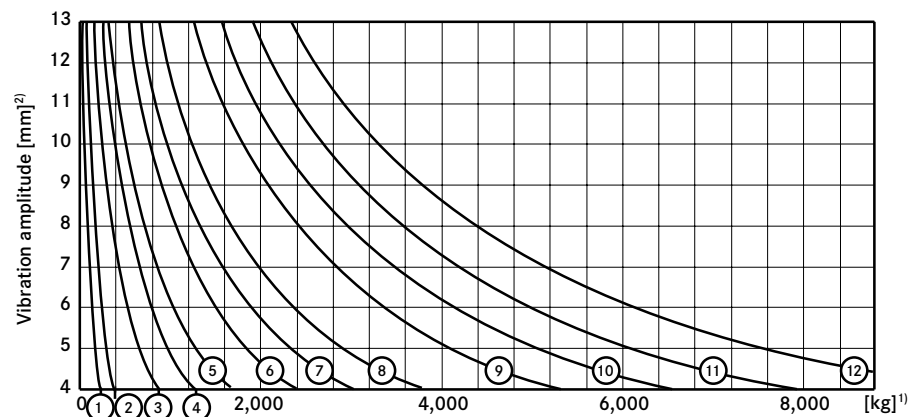

Performance graphs for 6-pole motors, synchronous speed 1,200 rpm (60 Hz)

Bildunterzeilen

1 = UVE 3 W	7 = UVH 38 W
2 = UVE 5 W	8 = UVH 46 W
3 = UVF 11 W	9 = UVL 64 W
4 = UVF 16 W	10 = UVK 79 W
5 = UVG 21 W	11 = UVN 95 W
6 = UVG 30 W	12 = UVP 119 W

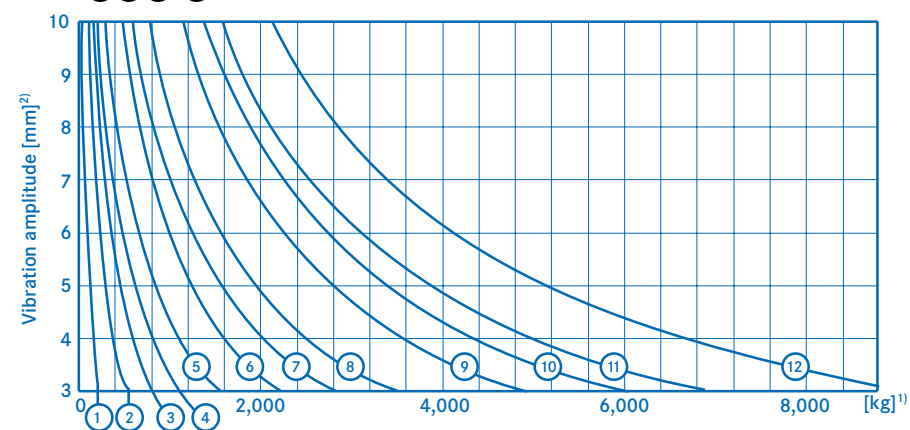

Performance graphs for 8-pole motors, synchronous speed 750 rpm (50 Hz)

1 = UVF 6 V	6 = UVL 36 V
2 = UVF 9 V	7 = UVK 44 V
3 = UVG 14 V	8 = UVN 76 V
4 = UVH 21 V	9 = UVP 85 V
5 = UVH 26 V	

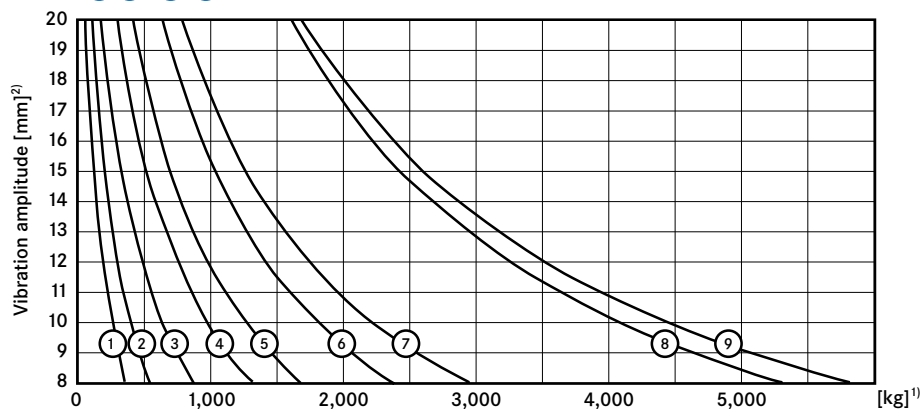

Performance graphs for 8-pole motors, synchronous speed 900 rpm (60 Hz)

1 = UVF 6 V	6 = UVL 36 V
2 = UVF 9 V	7 = UVK 44 V
3 = UVG 14 V	8 = UVN 76 V
4 = UVH 21 V	9 = UVP 85 V
5 = UVH 26 V	

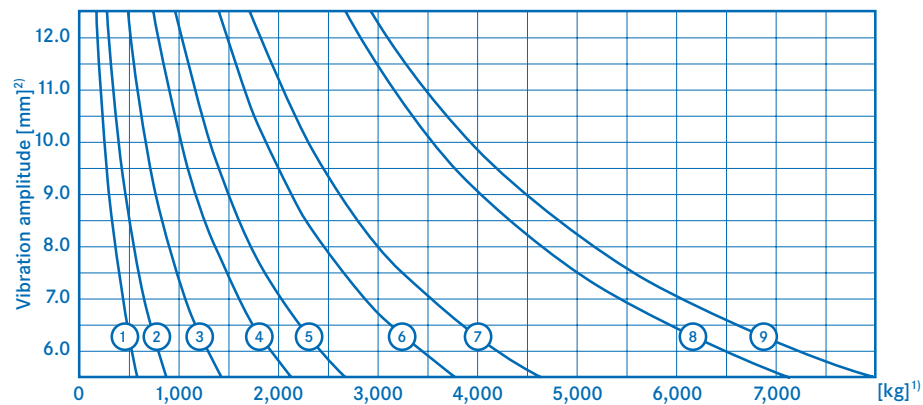

¹⁾ Working weight [kg] for devices driven by two motors
²⁾ Vibration amplitude from peak to peak

eUVE 5 W

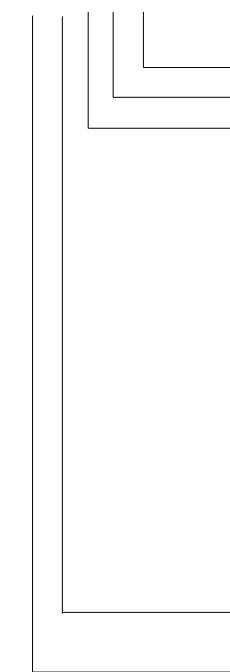

The Figures in te Type designation have the following meaning:

Number of poles (Y = 2-pole, X = 4-pole, W = 6-pole, V = 8-pole)
 Centrifugal force in kN
 Base dimensions, see table

Code	a	b	s	Mounting
1A	25-40	75	5,5	4 x M5
A	65	95	12	4 x M10
B	64-72	106	9	4 x M8
C	90	125	13	4 x M12
D	105	140	13	4 x M12
E	120	170	13	4 x M12
F	125	210	17	4 x M16
G	165	260	26	4 x M24
H	280	290	26	4 x M24
K	280	400	33	4 x M30
L	200	320	28	4 x M27
N	125/250	380	38	6 x M36
P	140/280	440	44	6 x M42

UV- Series



-protected series

2-Pole Motors with Synchronous Speeds 3,000/3,600 rpm

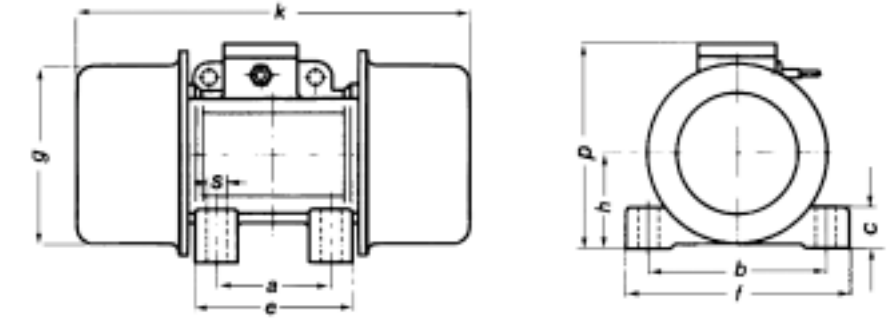

Type	Part No.	Therm-istor	Ex-proof ³⁾	CSA	Centrifugal force [N]	Working moment [kgcm]	Motor weight [kg]	Working weight range ¹⁾ [kg]		Rated Current max. [A]		Rated Power max. [kW]	Dimensions [mm]										
								from	to	Δ 230 V	Y 400 V		a	b	c	e	f	g	h	k	p	s	Screws
50 Hz (3,000 rpm)																							
UV1 A 0,04 Y ²⁾ 43125					39	0.08	0.9	Rüttler	Rüttler	0.13	-	0.02	25-40	75	9	59	90	56	31	113	62	5,5	M5
UV A 0,6 Y	19453	○		●	608	1.22	4.1	13	52	0.47	0.27	0.12	65	95	20	86	127	96	70	193	120	12,0	M8 (M10)
UV B 1 Y	44172	○		●	981	1.96	4.3	16	89	0.61	0.35	0.18	64-72	106	24	100	125	100	61	210	153	9,0	M8
UV B 1,9 Y	44174	○		●	1,890	3.82	5.0	38	183	0.61	0.35	0.18	64-72	106	24	100	125	100	61	225	153	9,0	M8
UV C 3 Y	44177	○	○	●	2,980	6.02	8.3	59	284	1.04	0.60	0.26	90	125	28	128	152	124	73	255	179	13,0	M12
UV D 5 Y	44182	○	○	●	4,930	9.98	13	99	473	1.39	0.80	0.45	105	140	30	140	167	143	83	284	203	13,0	M12
UV E 7,7 Y	20812	●	○	●	7,700	15.60	17	161	746	1.91	1.10	0.65	120	170	45	160	205	168	92	383	210	13,0	M12
UV E 11 Y	19943	●		●	10,800	22	23	230	1,055	3.00	1.75	1.00	120	170	54	162	205	187	104	372	233	13,0	M12
UV F 20 Y	16417	●	○	●	20,200	41	56	400	1,940	5.70	3.30	2.00	125	210	65	175	260	201	124	490	246	17,0	M16
UV G 32 Y	16421	●	○	●	31,600	64	103	595	2,995	11.30	6.50	4.00	165	260	65	230	330	270	160	594	334	26,0	M24
UV H 40 Y	16425	●		●	40,000	81	145	725	3,760	11.30	6.50	4.00	280	290	70	345	355	296	173	682	363	26,0	M24
UV L 62 Y	17127	●		●	62,400	126	184	1,210	5,930	15.90	9.20	5.50	200	320	90	270	390	334	189	666	381	28,0	M27
UV L 88 Y	16429	●		●	88,400	179	215	1,810	8,520	31.20	18.00	10.00	200	320	100	270	392	355	192	633	395	28,0	M27
60 Hz (3,600 rpm)										265 V		460 V											
UV1 A 0,04 Y ²⁾ 43125					59	0.08	0.85	Rüttler	Rüttler	0.30 (115V)	-	0.02	25-40	75	9	59	90	56	31	113	62	5,5	M5
UV A 0,6 Y	19454	○		●	690	0.98	3.80	10	57	0.40	0.23	0.12	65	95	20	86	127	96	70	193	120	12,0	M8 (M10)
UV B 1 Y	44187	○		●	942	1.31	4.10	16	79	0.52	0.30	0.18	64-72	106	24	100	125	100	61	210	153	9,0	M8
UV B 1,9 Y	44190	○		●	1,740	2.42	4.60	35	152	0.52	0.30	0.18	64-72	106	24	100	125	100	61	225	153	9,0	M8
UV C 3 Y	44200	○	○	●	2,910	4.08	7.80	58	256	0.78	0.50	0.27	90	125	28	128	152	124	73	255	179	13,0	M12
UV D 5 Y	44209	○	○	●	4,620	6.48	12	93	407	1.30	0.75	0.50	105	140	30	140	167	143	83	284	203	13,0	M12
UV E 7,7 Y	20814	●	○	●	7,400	10.40	16	157	661	1.73	1.00	0.69	120	170	45	160	205	168	92	383	210	13,0	M12
UV E 11 Y	20825	●		●	10,400	14.60	22	220	930	3.00	1.75	0.68	120	170	54	162	205	187	104	372	233	13,0	M12
UV F 20 Y	16419	●	○	●	18,200	25.60	54	360	1,600	5.00	2.90	2.00	125	210	65	175	260	201	124	490	246	17,0	M16
UV G 32 Y	16423	●	○	●	31,300	44.10	99	605	2,745	9.70	5.60	4.00	165	260	65	230	330	270	160	594	334	26,0	M24
UV H 40 Y	16427	●		●	40,200	56.60	141	750	3,490	9.70	5.60	4.00	280	290	70	345	355	296	173	682	363	26,0	M24
UV L 62 Y	17133	●		●	63,000	88.60	178	1,255	5,550	13.90	8.00	5.50	200	320	90	270	390	334	189	666	381	28,0	M27
UV L 88 Y	16431	●		●	88,000	124.00	210	1,835	7,850	22.50	13.00	9.30	200	320	100	270	392	355	192	633	395	28,0	M27

○ = Possible as option

● = Fitted as standard

¹⁾ For devices driven by two unbalance motors

²⁾ Single-phase AC unbalance motor with unchangeable fitted 3-core cable

³⁾ Explosionproof motors have different technical data

Motor housings in Series UV in standard colour RAL 5018, powder coated

4-Pole Motors with Synchronous Speeds 1,500/1,800 rpm

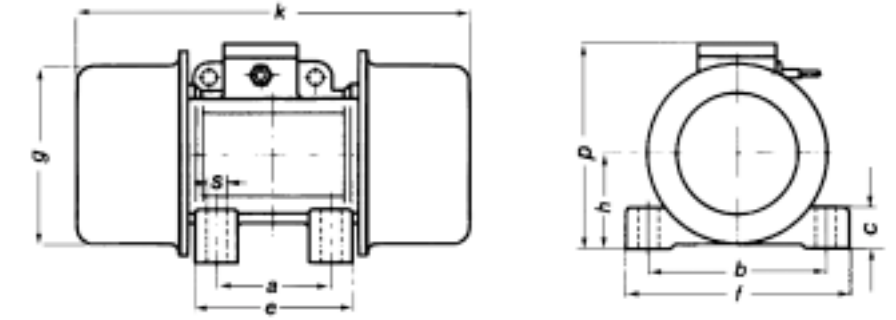

Type	Part No.	Therm-istor	Ex-proof ³⁾	CSA	Centrifugal force [N]	Working moment [kgcm]	Motor weight [kg]	Working weight range ¹⁾ [kg]		Rated Current max. [A]		Rated Power max. [kW]	Dimensions [mm]											
								from	to	Δ 230 V	Y 400 V		a	b	c	e	f	g	h	k	p	s	Screws	
50 Hz (3,000 rpm)																								
UV B 0,3 X	44169	○		●	265	2.0	4.4	1	19	0.36	0.21	0.09	64-72	106	24	100	125	100	61	210	153	9	M8	
UV B 0,7 X	44170	○		●	746	5.9	5.3	9	68	0.36	0.21	0.09	64-72	106	24	100	125	100	61	225	153	9	M8	
UV C 1,5 X	44175	○	○	●	1,460	11.8	9.9	19	137	0.71	0.41	0.17	90	125	28	128	152	124	73	295	179	13	M12	
UV C 2,1 X	44176	○	○	●	2,090	16.8	10.7	34	203	0.71	0.41	0.17	90	125	28	128	152	124	73	295	179	13	M12	
UV D 4 X	44180	○	○	●	4,040	32.6	17	75	400	1.04	0.60	0.30	105	140	30	140	167	143	83	340	203	13	M12	
UV D 5,4 X	44181	○	○	●	5,420	43.8	19	108	546	1.04	0.60	0.30	105	140	30	140	167	143	83	380	203	13	M12	
UV E 7X	19941	●	○	●	7,060	57.2	25	140	715	1.59	0.92	0.52	120	170	45	160	205	168	91	383	210	13	M12	
UV E 10 X	19942	●	○	●	10,300	83	31	215	1,045	1.65	0.95	0.55	120	170	54	162	205	187	104	438	233	13	M12	
UV F 18 X	16345	●	○	●	17,600	143	64	250	1,780	3.50	2.00	1.10	125	210	65	175	260	201	124	490	254	17	M16	
UV F 24 X	16349	●	○	●	23,700	192	83	475	2,395	5.50	3.20	1.60	125	210	65	175	260	231	140	525	278	17	M16	
UV G 38 X	16353	●	○	●	37,700	305	122	775	3,825	6.75	3.90	2.20	165	260	65	230	330	270	160	594	334	26	M24	
UV H 49 X	16357	●	○	●	49,100	398	168	990	4,970	10.39	6.00	3.60	280	290	70	345	355	296	173	682	363	26	M24	
UV L 64 X	17128	●		●	64,100	520	208	1,320	6,520	18.20	10.50	6.00	200	320	90	270	390	334	189	666	381	28	M27	
UV N 83 X	16361	●	○		82,600	669	317	1,600	8,290	21.10	12.20	7.50	2 x 125	380	35	320	460	387	215	866	436	38	6 x M36	
UV P 112 X	16365	●			112,000	909	433	2,165	11,255	30.30	17.50	10.00	2 x 140	440	38	370	530	420	230	994	454	44	6 x M42	
60 Hz (1,800 rpm)																								
UV B 0,3 X	44193	○		●	373	2.1	4.4	1	25	0.35	0.20	0.10	64-72	106	24	100	125	100	61	210	153	9	M8	
UV B 0,7 X	44219	○		●	765	4.2	5.1	9	60	0.35	0.20	0.10	64-72	106	24	100	125	100	61	225	153	9	M8	
UV C 1,5 X	44203	○	○	●	1,260	7.1	9.9	12	98	0.69	0.40	0.17	90	125	28	128	152	124	73	295	179	13	M12	
UV C 2,1 X	44206	○	○	●	2,100	11.8	9.9	34	176	0.69	0.40	0.17	90	125	28	128	152	124	73	295	179	13	M12	
UV D 4 X	44211	○	○	●	4,030	22.6	16.0	71	345	1.04	0.60	0.35	105	140	30	140	167	143	83	340	203	13	M12	
UV D 5,4 X	19488	○	○	●	5,810	32.6	18.0	113	508	1.04	0.60	0.35	105	140	30	140	167	143	83	380	203	13	M12	
UV E 7 X	20816	●	○	●	7,460	41.8	22.0	145	655	1.70	0.98	0.66	120	170	45	160	205	168	91	383	210	13	M12	
UV E 10 X	20817	●	○	●	9,630	54.2	31.0	180	845	1.65	0.95	0.68	120	170	54	162	205	187	104	438	233	13	M12	
UV F 18 X	16347	●	○	●	17,200	97.0	60.0	310	1,495	3.30	1.90	1.20	125	210	65	175	260	201	124	490	254	17	M16	
UV F 24 X	16351	●	○	●	24,000	135.0	77.0	445	2,095	5.20	3.00	1.70	125	210	65	175	260	231	140	525	278	17	M16	
UV G 38 X	16355	●	○	●	36,700	207.0	117.0	685	3,215	6.75	3.90	2.50	165	260	65	230	330	270	160	594	334	26	M24	
UV H 49 X	16359	●	○	●	48,500	273.0	160.0	895	4,230	8.66	5.00	3.40	280	290	70	345	355	296	173	682	363	26	M24	
UV L 64 X	17134	●		●	64,700	364.0	195.0	1,230	5,675	15.60	9.00	6.00	200	320	90	270	390	334	189	666	381	28	M27	
UV N 83 X	16363	●	○		87,500	492.4	303.0	1,580	7,595	20.80	12.00	8.50	2 x 125	380	35	320	460	387	215	866	436	38	6 x M36	
UV P 112 X	16367	●			112,000	633.2	411.0	1,990	9,730	26.80	15.50	10.50	2 x 140	440	38	370	530	420	230	994	454	44	6 x M42	

○ = Possible as option
 ● = Fitted as standard
¹⁾ For devices driven by two unbalance motors
²⁾ Explosionproof motors have different technical data
 Motor housings in Series UV in standard colour RAL 5018, powder coated

6-Pole Motors with Synchronous Speeds 1,000/1,200 rpm

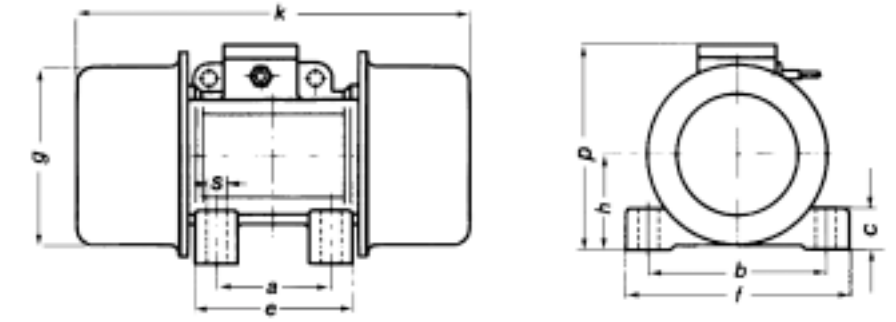

Type	Part No.	Therm-istor	Ex-proof ³⁾	CSA	Centrifugal force [N]	Working moment [kgcm]	Motor weight [kg]	Working weight range ¹⁾ [kg]		Rated Current max. [A]		Rated Power max. [kW]	Dimensions [mm]										
								from	to	Δ 230 V	Y 400 V		a	b	c	e	f	g	h	k	p	s	Screws
50 Hz (3,000 rpm)																							
UV E 3 W	19939	●	○	●	3,150	57	25	40	235	1.25	0.72	0.35	120	170	45	160	205	168	92	383	210	13	M12
UV E 5 W	19940	●	○	●	5,020	91	33	75	390	1.30	0.75	0.35	120	170	54	162	205	187	105	438	233	13	M12
UV F 11 W	16377	●	○	●	11,100	202	73	165	865	2.85	1.65	0.75	125	210	65	175	260	201	125	560	254	17	M16
UV F 16 W	16381	●	○	●	16,100	293	93	265	1,280	3.80	2.20	1.10	125	210	65	175	260	231	140	603	278	17	M16
UV G 21 W	16385	●	○	●	21,100	385	130	335	1,665	7.10	4.10	1.96	165	260	65	230	330	270	160	662	334	26	M24
UV G 30 W	16389	●		●	29,500	538	145	540	2,400	7.80	4.50	2.20	165	260	65	230	330	270	160	710	334	26	M24
UV H 38 W	16393	●	○	●	37,500	684	195	665	3,030	8.80	5.10	2.50	280	290	70	345	355	296	173	774	363	26	M24
UV H 46 W	16397	●		●	46,100	841	211	870	3,785	11.30	6.50	3.20	280	290	70	345	355	296	173	834	363	26	M24
UV L 64 W	17129	●		●	64,000	1,168	263	1,270	5,315	14.20	8.20	4.30	200	320	90	270	390	334	189	840	381	28	M27
UV K 79 W	16401	●			78,900	1,439	327	1,560	6,540	21.80	12.60	7.00	280	400	65	350	470	359	199	878	403	33	M30
UV N 95 W	16405	●	○		95,100	1,735	384	1,900	7,910	23.30	13.50	7.60	2 x 125	380	35	320	460	387	215	866	436	38	6 x M36
UV P 119 W	16409	●			119,000	2,163	500	2,330	9,815	28.20	16.30	9.00	2 x 140	440	38	370	530	420	230	994	454	44	6 x M42
60 Hz (1,200 rpm)																							
UV E 3 W	20810	●	○	●	3,320	42	23	40	235	1.18	0.68	0.38	120	170	45	160	205	168	92	383	210	13	M12
UV E 5 W	20811	●	○	●	7,230	91	33	115	545	1.18	0.68	0.38	120	170	54	162	205	187	105	438	233	13	M12
UV F 11 W	16379	●	○	●	11,300	143	65	155	825	2.60	1.50	0.75	125	210	65	175	260	201	125	490	254	17	M16
UV F 16 W	16383	●	○	●	15,200	192	84	215	1,115	3.80	2.20	1.30	125	210	65	175	260	231	140	525	278	17	M16
UV G 21 W	16387	●	○	●	21,100	268	120	295	1,550	6.50	3.75	2.10	165	260	65	230	330	270	160	594	334	26	M24
UV G 30 W	16391	●		●	30,400	375	130	490	2,240	7.40	4.30	2.40	165	260	65	230	330	270	160	710	334	26	M24
UV H 38 W	16395	●	○	●	37,600	476	177	600	2,820	8.70	5.00	3.00	280	290	70	345	355	296	173	774	363	26	M24
UV H 46 W	16399	●		●	46,000	583	190	785	3,505	10.40	6.00	3.60	280	290	70	345	355	296	173	774	363	26	M24
UV L 64 W	17132	●		●	64,000	811	234	1,155	4,940	14.00	8.10	5.00	200	320	90	270	390	334	189	840	381	28	M27
UV K 79 W	16403	●			78,400	993	293	1,400	6,040	19.60	11.30	7.50	280	400	65	350	470	359	199	878	403	33	M30
UV N 95 W	16407	●	○		89,400	1,133	343	1,580	6,870	21.50	12.40	8.00	2 x 125	380	35	320	460	387	215	866	436	38	6 x M36
UV P 119 W	16411	●			119,000	1,509	445	2,130	9,170	26.00	15.00	9.50	2 x 140	440	38	370	530	420	230	994	454	44	6 x M42

○ = Possible as option

● = Fitted as standard

¹⁾ For devices driven by two unbalance motors

²⁾ Explosionproof motors have different technical data

Motor housings in Series UV in standard colour RAL 5018, powder coated

8-Pole Motors with Synchronous Speeds 750/900 rpm

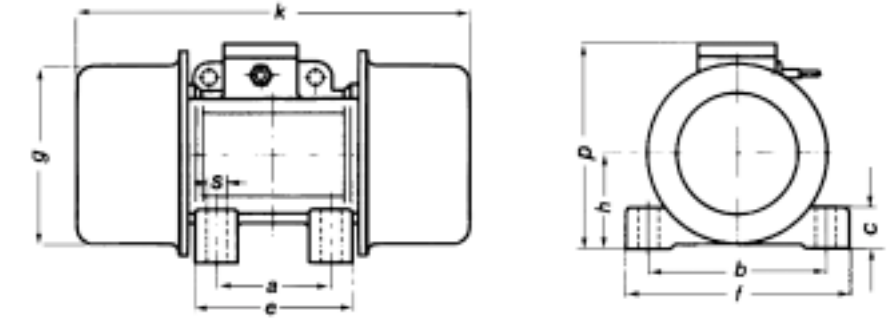

Type	Part No.	Therm-istor	Ex-proof ³⁾	CSA	Centrifugal force [N]	Working moment [kgcm]	Motor weight [kg]	Working weight range ¹⁾ [kg]		Rated Current max. [A]		Rated Power max. [kW]	Dimensions [mm]											
								from	to	Δ 230 V	Y 400 V		a	b	c	e	f	g	h	k	p	s	Screws	
50 Hz (3,000 rpm)																								
UV F 6 V	19865	●	●	●	6,250	202	73	55	360	2.40	1.40	0.40	125	210	65	175	260	201	124	560	246	17	M16	
UV F 9 V	19866	●	●	●	9,045	293	93	110	545	3.80	2.20	0.95	125	210	65	175	260	231	140	603	278	17	M16	
UV G 14 V	19867	●	●	●	14,350	465	145	175	810	7.10	4.10	1.50	165	260	65	230	330	270	160	710	334	26	M24	
UV H 21 V	19868	●	●	●	21,110	684	195	295	1,320	9.30	5.40	2.00	280	290	70	345	355	296	173	774	363	26	M24	
UV H 26 V	19869	●	●	●	25,950	841	211	420	1,680	10.40	6.00	2.50	280	290	70	345	355	296	173	834	363	26	M24	
UV L 36 V	19870	●	●	●	36,020	1168	263	640	2,395	14.20	8.20	4.00	200	320	90	270	390	334	189	840	381	28	M27	
UV K 44 V	19871	●	●	●	44,400	1439	327	785	2,945	17.10	9.90	4.90	280	400	65	355	470	359	200	878	403	33	M30	
UV N 76 V	19872	●	●	●	76,440	2478	438	1,600	5,320	22.80	13.20	6.80	2 x 125	380	35	320	460	387	215	1,002	436	38	6 x M36	
UV P 85 V	19873	●	●	●	85,240	2763	540	1,685	5,830	24.20	14.00	7.60	x 140	440	38	370	530	423	230	1,070	454	44	6 x M42	
60 Hz (900 rpm)																								
										265 V	460 V													
UV F 6 V	19891	●	●	●	8,995	202	73	175	590	2.60	1.30	0.50	125	210	65	175	260	201	124	560	246	17	M16	
UV F 9 V	19892	●	●	●	13,020	293	93	280	880	4.40	2.20	1.10	125	210	65	175	260	231	140	603	278	17	M16	
UV G 14 V	19893	●	●	●	20,670	465	130	485	1,430	7.30	4.20	1.79	165	260	65	230	330	270	160	710	334	26	M24	
UV H 21 V	19894	●	●	●	30,400	684	177	740	2,135	9.00	5.20	2.30	280	290	70	345	355	296	173	774	363	26	M24	
UV H 26 V	19895	●	●	●	37,350	841	190	965	2,680	10.40	6.00	3.00	280	290	70	345	355	296	173	834	363	26	M24	
UV L 36 V	19896	●	●	●	51,865	1,168	234	1,400	3,780	13.60	7.85	4.30	200	320	90	270	390	334	189	840	381	28	M27	
UV K 44 V	19897	●	●	●	63,930	1,439	293	1,715	4,645	16.50	9.50	5.80	280	400	65	355	470	359	200	878	403	33	M30	
UV N 76 V	19898	●	●	●	97,480	2,195	419	2,675	7,145	20.80	12.00	7.45	2 x 125	380	35	320	460	387	215	1,002	436	38	6 x M36	
UV P 85 V	19899	●	●	●	110,215	2,481	520	2,930	7,980	23.40	13.50	8.30	x 140	440	38	370	530	423	230	1,070	454	44	6 x M42	

○ = Possible as option

● = Fitted as standard

¹⁾ For devices driven by two unbalance motors

Motor housings in Series UV in standard colour RAL 5018, powder coated

Vibration technology in application



Drives and dosing technology

AVITEQ Vibrationstechnik GmbH (formerly AEG Vibrationstechnik) manufactures and distributes a full range of vibrating systems and drives including magnetic vibrators and unbalanced motors.

AVITEQ Vibrationstechnik GmbH offers every possible solution, whether your products have to be unloaded or loaded, conveyed horizontally or vertically, screened or graded, separated, drained, arranged, cooled down, warmed up or dried, condensed or vibrated and loosened.

Vibrating systems from AVITEQ Vibrationstechnik GmbH are used worldwide in practically every industry.

WE ARE CERTIFIED
Certificate Registration No.
QC-QM-Z-02/044-01



AVITEQ Vibrationstechnik GmbH

Geschäftsfeld Antriebe und Dosiertechnik
Im Gotthelf 16
D-65795 Hattersheim-Eddersheim

Tel. +49 (0) 6145 503-310
Fax +49 (0) 6145 503-312
E-Mail: komponenten@aviteq.de
Internet: www.aviteq.de

